

Heating Controller MHCC

Weather-compensated heating circuit controller

Installation and operating instructions

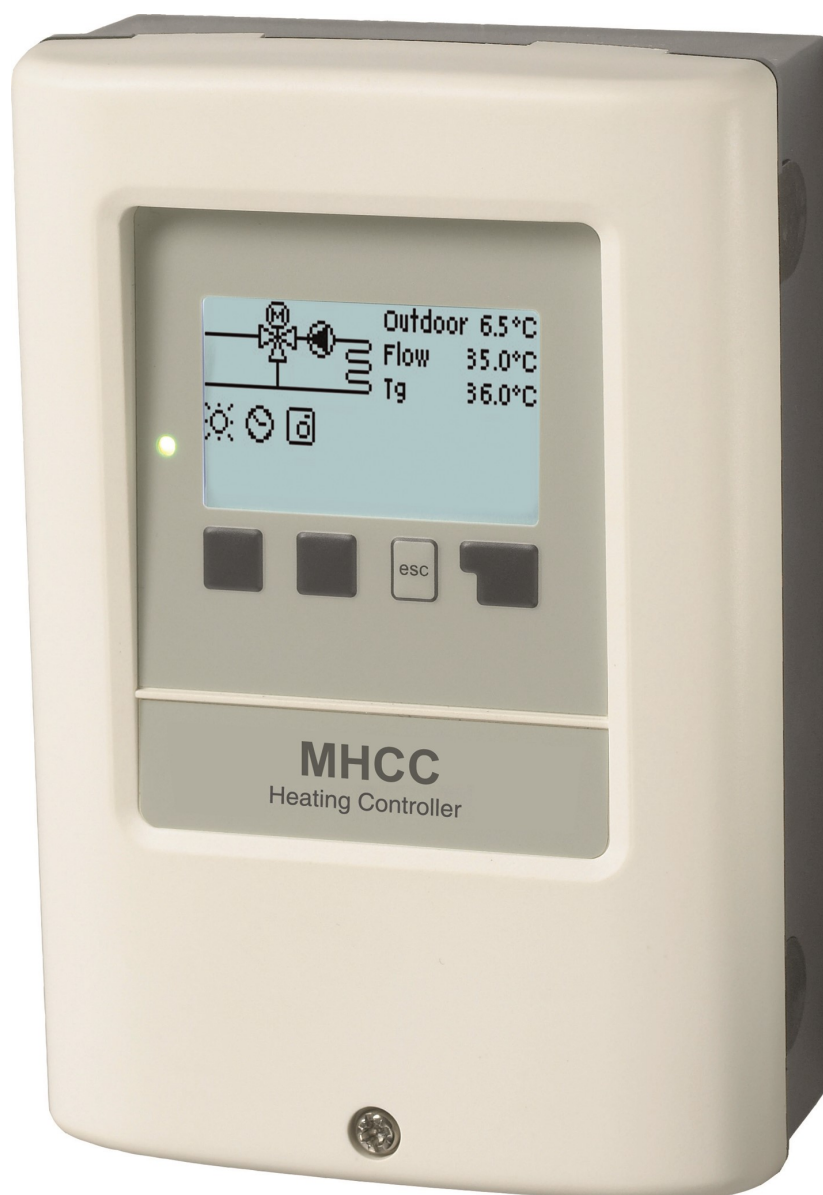

Read carefully before installation, commissioning and operation

CONTENT

Safety Instructions	3
EU-Conformity	3
General instructions	3
Explanation of Symbols	3
Changes to the Unit	4
Warranty and Liability	4
Disposal and Pollutants	4
Description MHCC	5
Specifications	5
About the Controller	6
Scope of Supply	6
Hydraulic Variants	6
Wall Installation	7
Installation	8
Electrical Terminals	8
Additional Information	9
External relay at signal output V(X) (0-10V / PWM)	9
Electrical Terminals	9
Electrical Connection	10
Installing the Temperature Sensors	10
Temperature Resistance Table for Pt1000 Sensors	10
Combining multiple SOREL products	10
CAN bus	10
°CALEON Room Controller	11
RC21 Room thermostat with remote control	14
Operation	15
Display and Input	15
Commissioning help	16
1. Measurement values	17
2. Statistics	17
Today	17
28 days	17
Operating hours	17
Notifications	17
Reset / Clear	17
3. Periods	18
Time & Date	18
Daylight saving time	18
Heating Circuit (Day)	18
Heating Circuit Comfort	18
4. Operating mode	18
Manual	18
5. Settings	19
Operating mode	19
S/W Day	19
S/W Night	19
Curve	19
Day Correction	20
Night Correction	20
Comfort Temperature Boost	20
Min. Flow	20
Max. Flow	20
Heating circuit off	20
Heat request	21
Eco mode (during solar charge)	21
Reference/Actual -	21
Insulation factor	21
Threshold	21
Mod. Offset	22
14-day Reference	22
6. Protective Functions	22
Seizing Protection	22
Frost Protection	22
Min. Flow	22
Max. Flow	22
Discharge Protection	22
7. Special Functions	23
Sensor Calibration	23
Commissioning	23
Factory Settings	23
Mixer	23
Turn Time	23
Pause Factor	23
Increase	23
Room Controller	24
Eco Display Mode	24
Network	24
Access Control	24
Ethernet	25
CAN bus ID	25
Sensor send interval	25
8. Menu Lock	25
9. Service Values	26
10. Language	26
Malfunctions/Maintenance	26
Tips	27
Support Guideline	27
Final Declaration	28

EU-Conformity

By affixing the CE mark to the unit the manufacturer declares that the MHCC conforms to the following relevant safety regulations:

- EU low voltage directive 2014/35/EU
- EU electromagnetic compatibility directive 2014/30/EU

conforms. Conformity has been verified and the corresponding documentation and the EU declaration of conformity are kept on file by the manufacturer.

General instructions

Please read carefully!

These installation and operating instructions contain basic instructions and important information regarding safety, installation, commissioning, maintenance and the optimal use of the unit. Therefore these instructions must be read and understood completely by the installation technician/specialist and by the system user before installation, commissioning and operation of the unit.

This unit is an automatic, electrical weather-compensated heating circuit controller for heating systems for/in Heating system and similar applications. Install the device only in dry rooms and under environmental conditions as described under "Technical Data".

The valid accident prevention regulations, VDE regulations, the regulations of the local power utility, the applicable DIN-EN standards and the installation and operating instruction of the additional system components must also be observed.

Under no circumstances does the unit replace any safety devices to be provided by the customer!

Installation, electrical connection, commissioning and maintenance of the device may only be carried out by an appropriately trained specialist. Users: Make sure that the specialist gives you detailed information on the function and operation of the unit. Always keep these instructions in the vicinity of the unit.

The manufacturer does not take over any liability for damage caused through improper usage or non-compliance of this manual!

Explanation of Symbols



Danger

Failure to observe these instructions can result in electrocution.



Danger

Failure to observe these instructions can result in serious damage to health such as scalding or life-threatening injuries.



Caution

Failure to observe these instructions can result in destruction of the unit or the system, or environmental damage.



Caution

Information which is especially important for the function and optimal use of the unit and the system.

Changes to the Unit

- Changes, additions to or conversion of the unit are not permitted without written permission from the manufacturer.
- It is likewise forbidden to install additional components that have not been tested together with the unit.
- If it becomes clear that safe operation of the unit is no longer possible, for example because of damage to the housing, turn the Unit off immediately.
- Any parts of the unit or accessories that are not in perfect condition must be exchanged immediately.
- Use only original spare parts and accessories from the manufacturer.
- Markings made on the unit at the factory must not be altered, removed or made illegible.
- Only the settings described in these instructions may be set using the Unit.



Changes to the unit can compromise the safety and function of the unit or the entire system.

Warranty and Liability

The unit has been manufactured and tested with regard to high quality and safety requirements. The unit is subject to the statutory guarantee period of two years from the date of sale. The warranty and liability shall not include, however, any injury to persons or material damage that is attributable to one or more of the following causes:

- Failure to observe these installation and operating instructions.
- Improper installation, commissioning, maintenance and operation.
- Improperly executed repairs.
- Unauthorised structural changes to the unit.
- Use of the device for other than its intended purpose.
- Operation above or below the limit values listed in the 'Specifications' section.
- Force majeure.

Disposal and Pollutants

The unit conforms to the European RoHS 2011/65/EU for the restriction of the use of certain hazardous substances in electrical and electronic equipment.



Under no circumstances may the device be disposed of with the normal household waste. Dispose of the unit only at appropriate collection points or ship it back to the seller or manufacturer.

Specifications

Model	MHCC	Weather-compensated heating circuit controller
Temperature controller class	VI	
Energy efficiency	4%	ErP Class VIII / When operating at min. 3 ° CALEONs or RC20 a energy efficiency of 5% is achieved
Standby loss	0,5 W	
Request type heater	On / off operation or modulating or via other devices in the CAN network	
Electrical specifications:		
Power supply		230 VAC +/- 10%, 50 ... 60 Hz
Power consumption / standby		0,5 W - 2,3 W/ 0,5 W
Total switched power		460 VA
Switched power per relay		460 VA for AC1 / 185 W for AC3
Internal fuse	1	2A slow blow 250V
Protection Class		IP40
Protection Class		II
Overvoltage category		II
Degree of pollution category		II
Inputs/Outputs		Measuring range
Sensor inputs	4	Pt1000 temperature sensor -40 °C ... 300 °C
Sensor inputs RC21	1	RC (S3 and S4)
Outputs mechanical relay	3	
mechanical relay	R1 - R3	460VA for AC1 / 460VA for AC3
0-10V/PWM output	V1	for 10 k Ω working resistance 1 kHz, level 10 V
+ Terminal/ Voltage output	+	Max. load by external devices 24V/2W (e.g. power supply of 1 °CALEON room controller)
Max. cable length		
CAN		< 3 m; at >= 3 m, a shielded twisted pair cable must be used. Isolate shielding and connect it to the protective conductor of only one of the devices. Max. cable length of the complete system 200 m.
0-10V/PWM		< 3 m
24 VDC		< 30 m
mechanical relay		< 10 m
Interface		
Fieldbus		CAN
Permissible Ambient Conditions		
for controller operation		0 °C - 40 °C, max. 85 % rel. humidity at 25 °C
for transport/storage		0 °C - 60 °C, no moisture condensation permitted
Other Specifications and Dimensions		
Housing Design		2-part, ABS plastic
Installation Methods		Wall installation, optionally panel installation
Overall dimensions		163 mm x 110 mm x 52 mm
Aperture installation dimensions		157 mm x 106 mm x 31 mm
Display		Fully graphical display, 128 x 64 dots
Light diode		multicolour
Real Time Clock		RTC with 24 hour power reserve
Operation		4 entry keys

About the Controller

The weather-compensated heating circuit controller for heating systems MHCC facilitates efficient use and function control of your Heating system possible while its handling is intuitive. After every input step the suitable functions are matched to the keys and explained in a text above. In the menu 'measurement values and settings' are help text and graphics in addition to key words.

The MHCC can be used with different variants of installations, See "Hydraulic Variants" on page 6.

Important characteristics of the MHCC are:

- Depiction of graphics and texts using a lit display.
- Simple viewing of the current measurement values.
- Statistics and system monitoring by means of statistical graphics
- Extensive setting menus with explanations.
- Menu block can be activated to prevent unintentional setting changes.
- Resetting to previously selected values or factory settings.

Scope of Supply

- Weather-compensated heating circuit controller MHCC
- 3 screws 3,5 x 35 mm and 3 plugs 6 mm for wall installation.
- MHCC Installation and operating instructions

Optionally contained depending on design/order:

- Outdoor sensor: 1x outdoor sensor e.g. TA52 (Pt1000) - article number 87000
- Pt1000 temperature sensor: 1x pipe-mounted sensor e.g. TR/P4 (Pt1000) - article number 81140
- Room Controller: °CALEON article number 70001 / °CALEON Clima article number 70002
- CAN Bus Accessories: CAN-Bus connection set with 1 or 2.9 meter cable - article number 89201 or 89203
- External relay with potential free contact - article number 77502

Hydraulic Variants



The following illustrations should be regarded only as schematic representations of the respective hydraulic systems and do not claim to be complete. Under no circumstances should the controller replace any safety devices. Depending on the specific application, additional system and safety components such as check valves, non-return valves, safety temperature limiters, scalding protectors, etc., may be required.

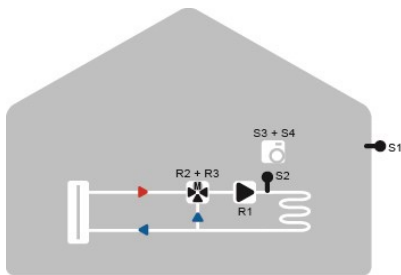

Mixed heating circuit

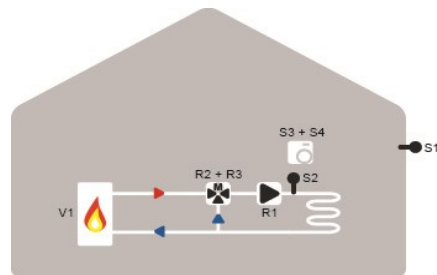

Mixed heating circuit with heat request

Wall Installation

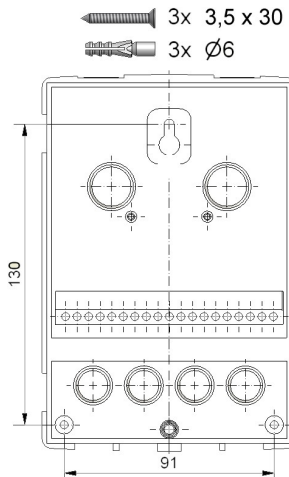
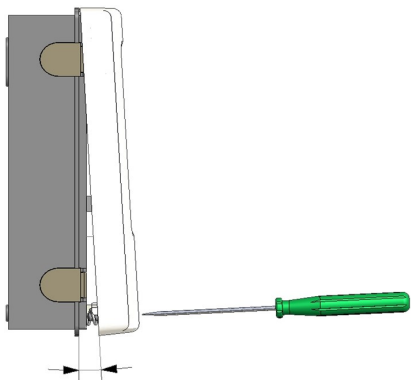

1. Unscrew cover screw completely.
2. Carefully pull upper part of housing from lower part. During the removal, the brackets are released as well.
3. Set upper part of housing aside. Do not touch the electronics.
4. Hold the lower part of the housing in the selected position and mark the 3 mounting holes. Make sure that the wall surface is as even as possible so that the housing does not become distorted when screwed on.
5. Using a drill and size 6 bit, drill three holes at the points marked on the wall and push in the plugs.
6. Insert the upper screw and screw it in lightly.
7. Fit the upper part of the housing and insert the other two screws.
8. Align the housing and tighten the three screws.

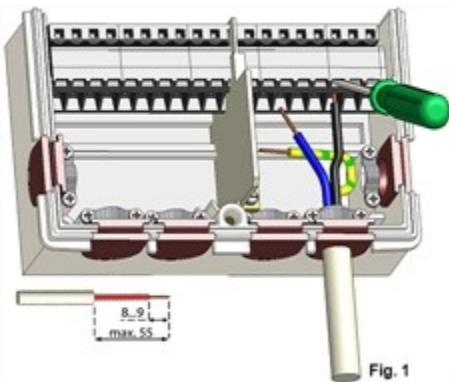

Fig. 1

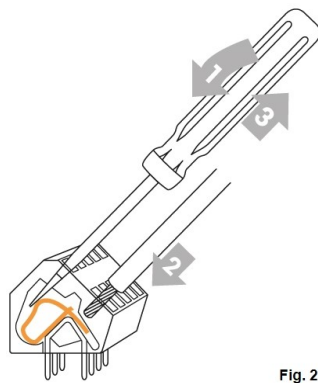

Fig. 2

1. Open the terminal cover.
2. Strip lines a max. of 55 mm, assemble the strain reliefs, strip wire ends 8-9 mm (Figure 1)
3. Open the terminals with a fitting screwdriver (figure 2) and connect the electrical system to the controller.
4. Clip on the terminal cover again and close it with the screw.
5. Turn on mains supply and put the controller into operation.

If problems occur with the operation of the terminals, our video on our YouTube page can help you:

YouTube

<http://www.sorel.de/youtube>



Electrical Terminals

Low voltages
max. 24 VAC / DC

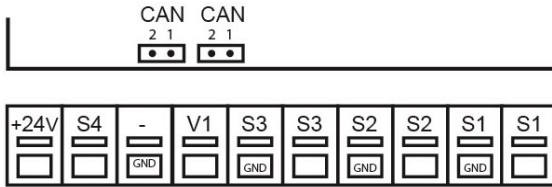

Mains voltages
230 VAC 50 - 60 Hz

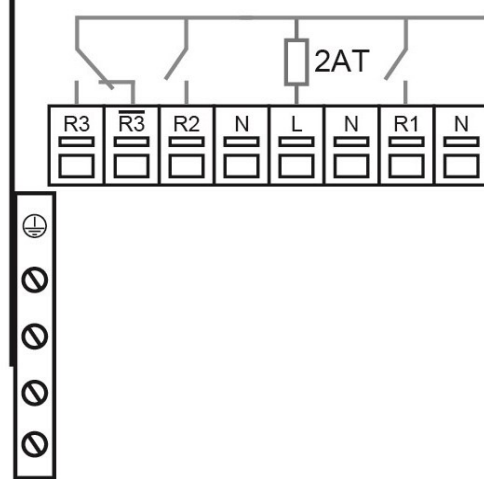

Terminal:	Connection for:
S1	Outdoor sensor
S1	Outdoor sensor (GND)
S2	Flow temperature sensor
S2	Flow temperature sensor (GND)
S3	Room sensor (RC21)
S3	Sensor ground (GND-RC21)
V1	0-10V output; heat request Install additional relays (item number 77502) if request is done via a normally open contact.
-	GND for heat request
S4	Remote control (RC21)
+ Terminal/ Voltage output	24 V/DC power supply for external devices Max. load by external devices 24V / 2W

Terminal:	Connection for:
N	Pump
R1	Pump
N	Mains phase conductor
L	Mains phase conductor
N	Neutral Mixer
R2	Mixer open
R3	not used 230 V
R3	Mixer close

! The PE protective conductor must be connected to the PE metal terminal block!

On the control board	
CAN	To connect several controllers with each other using a CAN cable. Terminate the CAN Bus on both ends using resistors, with the assignment of the CAN bus connectors being arbitrary!

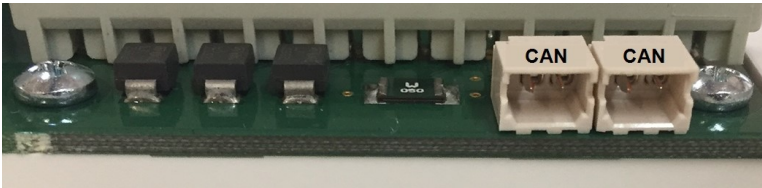

! At R3l are permanently 230v when the relay is inactive. Wrong wiring can damage the connected components.

External relay at signal output V(X) (0-10V / PWM)

Using an external relay (art. no. 77502), a 0-10V/PWM output V(1) can be used to get a switching power of 230 VAC (I) or a potential-free changeover contact (II). The external relay is activated via the signal output (0V = "off" (0 VAC or opened or closed), 10V = "on" (230 VAC or closed or opened)).

1. Connect external 0-10V relay to signal output, e.g. V1.
2. Settings heat request define to "switch". Hereby the relay is activated via the signal output V1 in case of a heat request.

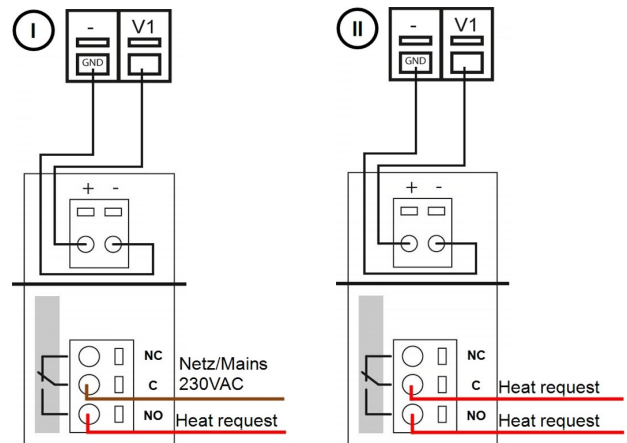

Electrical Terminals

! The connection of the ground wire is made at the lower gray terminal block. The neutral conductor N is connected to terminal block N. The PE protective conductor must be connected to the PE metal terminal block!

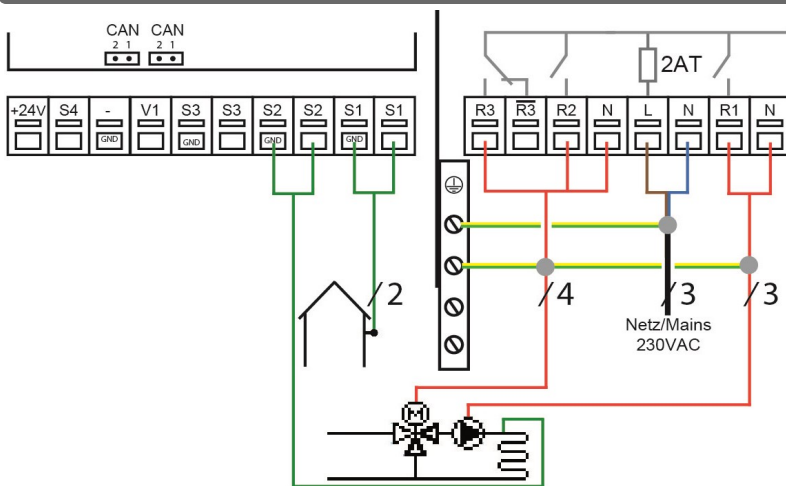

Mixed heating circuit

Terminal:	Connection:	Terminal:	Connection:
S1	Outdoor sensor	N	Pump
S1	GND	R1	Pump
S2	Flow sensor	N	Neutral conductor N
S2	GND	L	Network outer conductor L
S3	Room controller (optional)	N	Mixer
S3	GND	R2	Mixer open
V1	-	R3	
-	GND	R3	Mixer close
S4	Room controller (optional)		
+24V	24V voltage output Max. external devices 24V/2W		

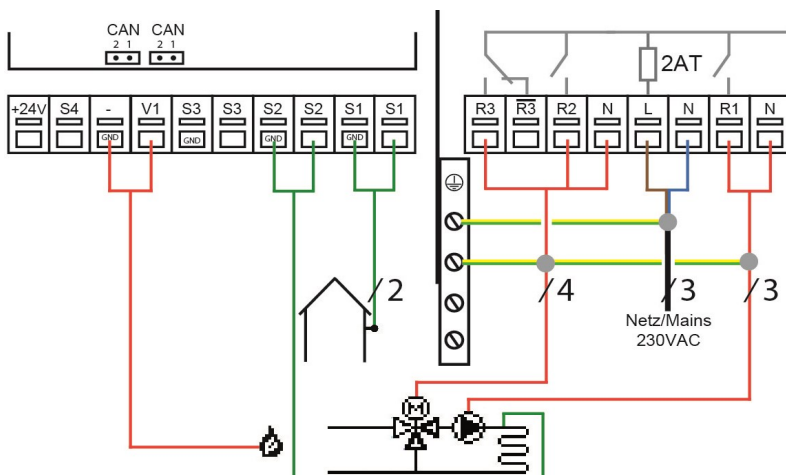



Mixed heating circuit with heat request

Terminal:	Connection:	Terminal:	Connection:
S1	Outdoor sensor	N	Pump
S1	GND	R1	Pump
S2	Flow sensor	N	Neutral conductor N
S2	GND	L	Network outer conductor L
S3	Room controller (optional)	N	Mixer
S3	GND	R2	Mixer open
V1	Heat request	R3	
-	GND	R3	Mixer close
S4	Room controller (optional)		
+24V	24V voltage output Max. external devices 24V/2W		

Electrical Connection

 Before working on the unit, switch off the power supply and secure it against being switched on again! Check that there is no power flowing! Electrical connections may only be made by a specialist and in compliance with the applicable regulations. The unit may not be put into operation if there is visible damage to the housing, e.g. cracks.

 The unit may not be accessible from behind.

 Low-voltage cables such as temperature sensor cables must be routed separately from mains voltage cables. Feed temperature sensor cables only into the left-hand side of the unit, and mains voltage cables only into the right-hand side.

 The customer must provide an all-pole disconnecting device, e.g. an emergency heating switch.

 The cables being connected to the unit must not be stripped by more than 55 mm, and the cable jacket must reach into the housing just to the other side of the strain relief.

Installing the Temperature Sensors

The controller operates with Pt1000 temperature sensors which are accurate to 1 °C, ensuring optimal control of system functions.

 If desired, the sensor cables can be extended to a maximum of 30 m using a cable with a cross-section of at least 0.75 mm². Ensure there is no contact resistance! Position the sensor precisely in the area to be measured! Only use immersion, pipe-mounted or flat-mounted sensors suitable for the specific area of application with the appropriate permissible temperature range.

Temperature Resistance Table for Pt1000 Sensors

°C	-20	-10	0	10	20	30	40	50	60	70	80	90	100
Ω	922	961	1000	1039	1077	1116	1155	1194	1232	1270	1308	1347	1385

Combining multiple SOREL products

SOREL devices with CAN Bus such as HCC controller, Datalogger or °CALEON Room Controller can be networked to communicate with each other and intelligently control larger systems.

CAN bus

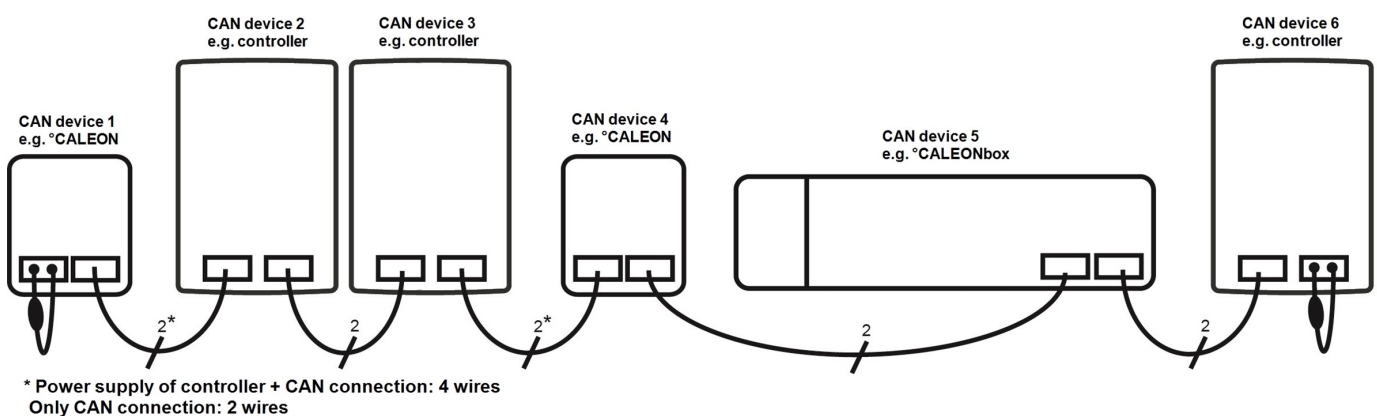

1. The CAN devices are connected in series with the CAN bus cable.
2. The first and last CAN device in this connection in series must be fitted with terminating resistance.

The wiring of the two CAN sockets is arbitrary.

°CALEON Room Controller



°CALEON is an optional accessory and is normally not included in the scope of supply.

Accessories

Each °CALEON comes with an accessory bag that contains everything (except the CAN cable) needed to connect to an HCC. The following components are used for the electrical connection:

1. Molex adapter for the CAN connection
2. Single wire connector to easily connect the Molex adapter to the CAN cable
3. Terminating resistor for the 2nd CAN bus connection on the HCC (if it is not used).



Can cable: <3m; at ≥ 3 m a shielded, twisted-pair cable is to be used. Isolate shielding and connect it to the protective conductor on one end. Max. cable length of the complete system 200 m.

Wiring

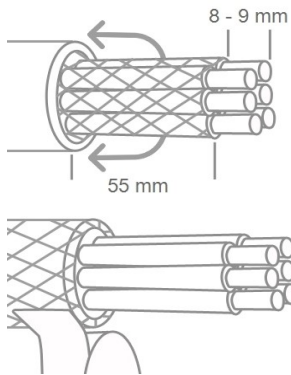

Cable strip off max. 55 mm, insulate all wire ends 8-9 mm and insert shielding over the cable. Insulate the entire shielding with tape.



Wire ferrules made of brass can be difficult to clamp due to their asymmetric crimping shape. In this case, remove the wire ferrule. The plug-in terminals are also suitable for flexible cables.



Any contact between protective conductor and circuit board can cause serious damage.

Wiring of a °CALEON with controller

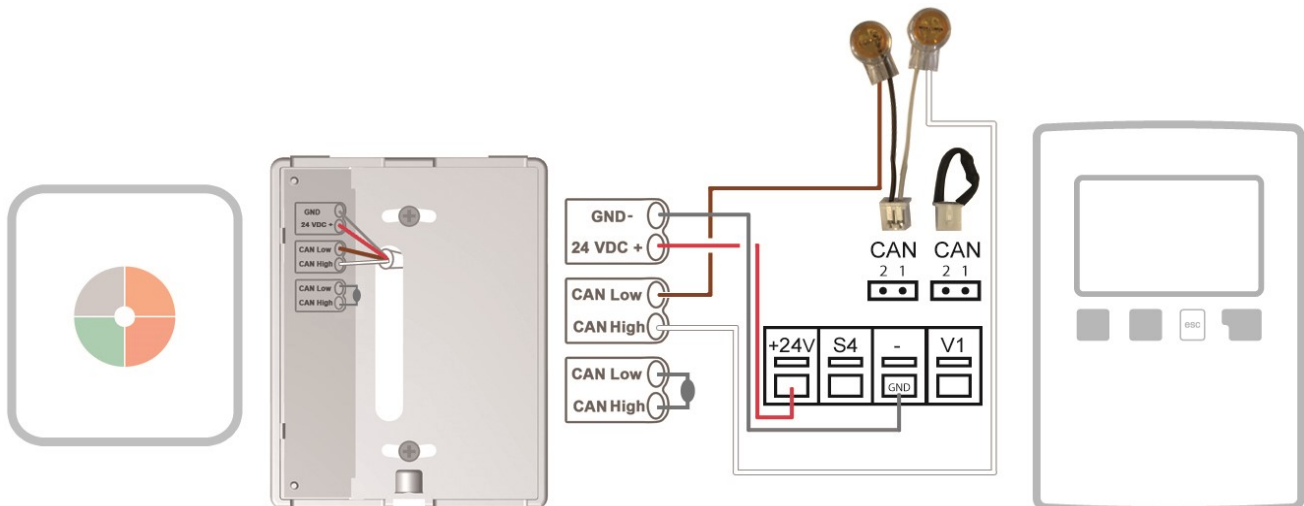

When connecting the CAN-Bus cable, make sure that the correct pairs of wires are twisted. The assignment is identical to the terminal pairs on the °CALEON room controller.

- > GND + 24VDC
- > CAN Low + CAN High

Wiring of several °CALEONs with controller

! The 24V power supply of the MHCC is designed for a load of up to 2W. This can supply 1 °CALEON room controller. For loads > 2W, an external power supply must be used.

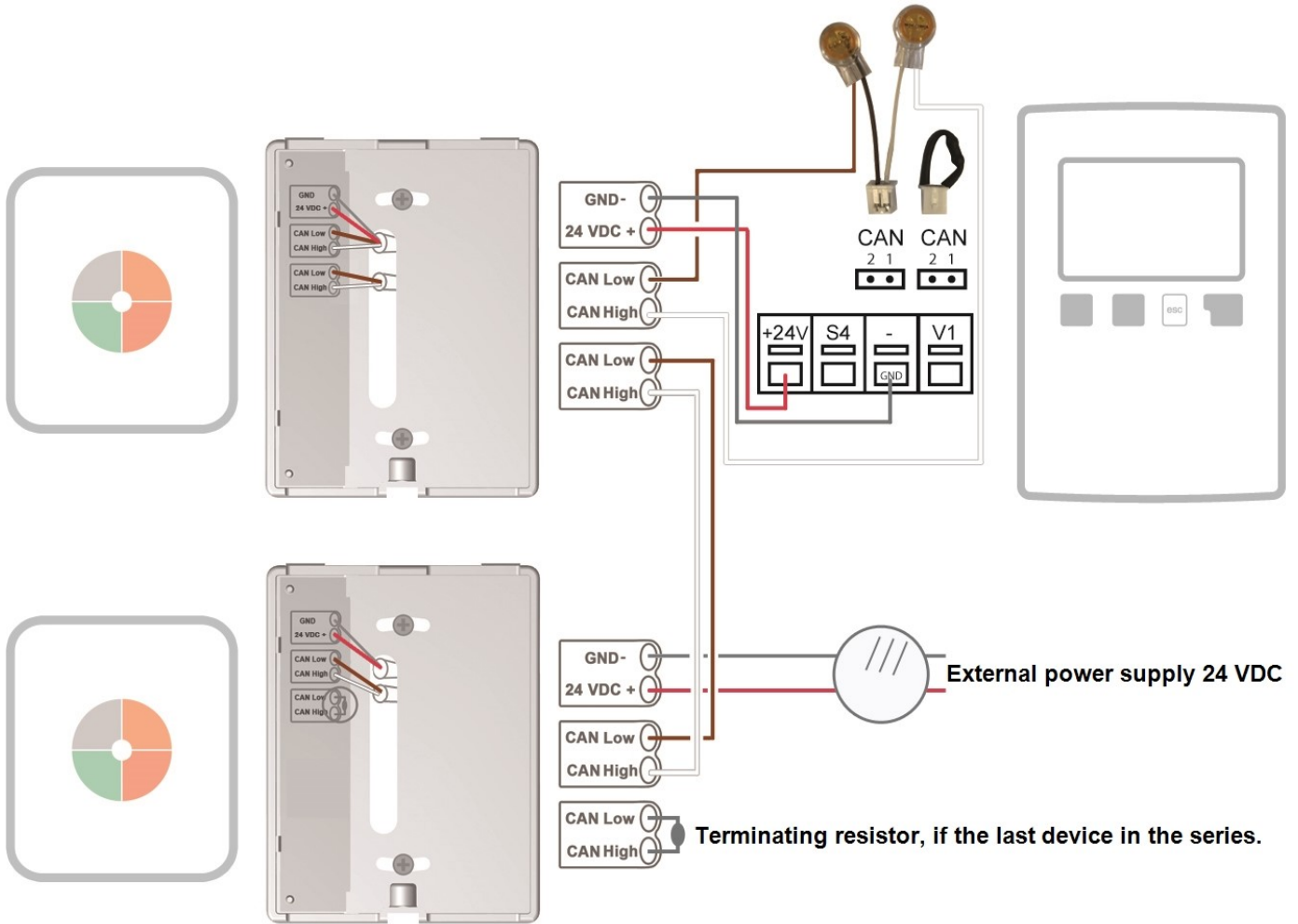

Configuration

First, the °CALEON must be set up directly on the room controller. The automatic start-up wizard (Overview > Operating Mode > Menu > Expert > Factory Settings) and the °CALEON user manual will help you.

! If not already done, set up the HCC now with the help of the commissioning wizard.

The setup of the room controller is done in the following menu:















7. Special functions -> 7.5. Room controller

7.5.5. Thermostat

Here, you select the room created in °CALEON. The rooms represented by symbols in °CALEON are given written names in the HCC.

The assignment can be found in the following table.

	Bathroom		Children 3		Room 2
	Bathroom 2		Corridor		Room 3
	Bathroom 3		Corridor 2		Room 4
	Bathroom 4		Dining		Room 5

	Bedroom		Kitchen		Room 6
	Bedroom 2		Living		Room 7
	Bedroom 3		Office		Room 8
	Children		Office 2		Room 9
	Children 2		Room 1		Room 10

7.5.1. Room controller

This value is used to appoint the amount of influence the room temperature has on the reference flow temperature, as a percentage. For each degree deviation between room temperature and set point temperature, the percentage set here is added from the calculated set flow temperature to the set flow temperature or subtracted from it until the min. or max. values set under the protective functions.

Example: Reference room temp.: e.g. 25 °C; room temp.: e.g. 20 °C ±5 °C. Calculated reference temp.: e.g. 40 °C: room controller: 10 % = 4 °C 5 X 4 °C = 20 °C. Accordingly, 20 °C are added to the reference flow temperature, giving 60 °C. If the value is higher than the one set in max. flow temp, the resulting temperature is the one set in max. flow temp.

 The setting parameters "7.5.2. Room ref. day" and "7.5.3. Room ref. night" have no influence when using a °CALEON and can be ignored.

Under „7.5.6. Thermostat 2" further °CALEONs can be set optionally as room controllers. The same system as for the first room controller applies.

5. Settings -> 5.11. HC off

If you want the heating circuit to switch off in addition to summer-winter shutdown, even if the room temperature is reached, set "summer + room" here.

RC21 Room thermostat with remote control

 The RC21 room thermostat is an optional accessory and is normally not included in the scope of supply.

The remote control with integrated thermostat RC21 provides you with easy to use temperature controlled adjustment of the temperature from within your living space.

Setting options



The RC21 control dial parallel shifts the heating circuit characteristic stored in the controller. The flow temperature (depending the outdoor temperature) is increased or decreased respectively by this. When the dial is turned all the way down, the heat circuit is switched off. Frost protection stays active to prevent damage.

Temperature Sensors

The RC21 room thermostat has a built-in temperature sensor, the values of which are registered, used and displayed in the controller. If the settings in the controller allow it, the sensor is used to alter the flow temperature.

Operating Modes

The slider can be moved to the following operating modes.

-  In automatic mode, the temperature is controlled according to the set thermostat periods.
-  In continuous day mode, the set times are ignored and the temperature is controlled according to the day settings.
-  In continuous night mode, the temperature is usually reduced. This setting is suitable, for example, for periods of prolonged absence (e.g. holidays).

Installation

Carefully remove the dial from the housing with a screwdriver. Loosen the screw beneath. Remove the light-coloured part of the housing from the base.

The RC21 is connected to the controller via 3 wires.

- 1) Remote control -> to a free sensor input (S1 - S4)
- 2) Temperature sensor -> to a free sensor input (S1 - S4)
- 3) GND

The following picture shows exemplary wiring.

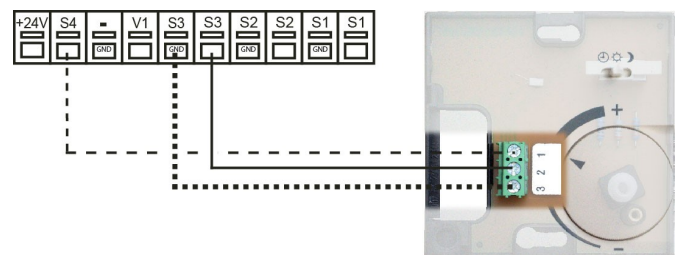

The setup of the room controller is done in the following menu:

7. Special functions -> 7.5. Room controller

7.5.5. Thermostat

select "RC21-Local 1".

7.5.13. RC-local:1 Type

Select here the sensor input that you use for the temperature sensor (Terminal 1) of the RC21.

„7.5.2. Room ref. day“ / „7.5.3. Room ref. night“

Setting the desired room temperature for day/night operation.

7.5.1. Room Controller

This value is used to appoint the amount of influence the room temperature has on the reference flow temperature, as a percentage. For each degree deviation between room temperature and reference temperature, the percentage of the calculated set flow temperature set here is added to the set flow temperature or subtracted from it up to the min. or max. values set under the protective functions.

Example: Reference room temp.: 25 °C; room temp.: 20 °C = 5 °C deviation. Calculated reference flow temp.: 40 °C: room controller: 10 % = 4 °C 5 X 4 °C = 20 °C. Accordingly, 20 °C are added to the reference flow temperature, giving 60 °C. If the value is higher than the one set in "Max. flow temp", the resulting temperature will be the one set in "Max. flow temp".

Under „7.5.6. Thermostat 2" further °CALEONs can be set optionally as room controllers. The same system as for the first room controller applies.









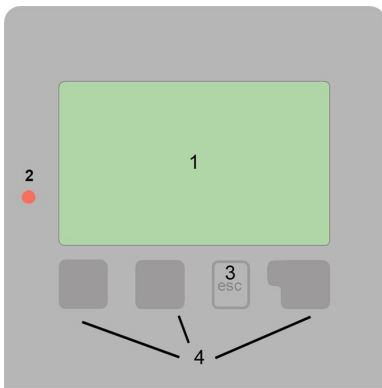





5. Settings -> 5.11. Heating circuit off

If you want the heating circuit to switch off in addition to summer-winter shutdown, even if the room temperature is reached, set "summer + room" here.

 The RC21 is suited for low voltage only!

Display and Input



-  Pump (rotates when active)
 -  Mixer (black when active)
 -  HC -Day mode (Time progr.)
 -  HC-Night mode (Time progr.)
 -  HC-Comfort mode (Time progr.)
 -  Day mode
 -  Night mode
 -  Day mode due to RC21
 -  Night mode due to RC21
 -  Heat request on/off
 -  Heat request incoming from CAN bus
 -  Heat requested over CAN bus
 -  Reference value mode
 -  Reference value 14 day
 -  External thermostat off
- Further symbols can be found in the special functions

Examples for key settings:

- +/- Increase / decrease values
- ▼/▲ Scroll menu down / up
- Yes/No agree / reject
- About further information
- Back to the previous display
- Ok Confirm selection
- Confirm Confirm setting

The display's (1), extensive text and graphical mode, enables simple, almost self-explanatory, operation of the controller.

The LED (2) lights up green when the primary pump is switched on (automatic mode). The LED (2) lights up red when operating mode 'Off' is set. The LED (2) flashes quickly red when an error is present.

Entries are made using 4 keys (3+4), to which contextual functions are assigned. The 'esc' key (3) is used to cancel an entry or to exit a menu. If applicable, a request for confirmation appears to save the made changes.

The function of the other 3 keys (4) is shown in the display right above the keys. The right-hand key generally has a confirmation and selection function.

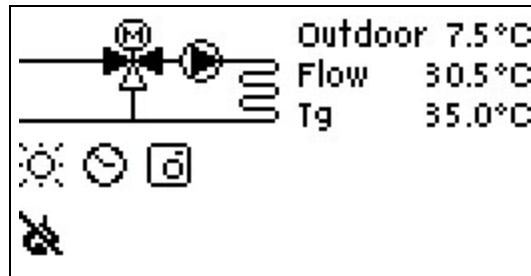

The graphics mode appears if not key is pressed for 2 minutes or after exiting the main menu with 'esc'.

The temperature overview appears when you press the left button. Tapping the button again leads back to the graphic overview.

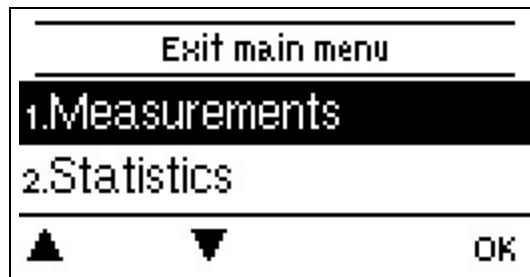

Hitting the "esc" key in the graphics mode takes you directly to the main menu.



1. Set language and time
2. Commissioning help / setup wizard
 - a) select or
 - b) skip.

The setup wizard guides through the necessary basic settings in the correct order. Every parameter is explained on the display of the controller. Pressing the „esc“ key takes you back to the previous setting.

b) With free commissioning the settings should be made in the following order:

- menu 10. Language
- menu 3. Time, Date and Operating Times.
- Menu 5. Settings, all values
- menu 6. Protection Functions (if any adjustments necessary).
- menu 7. Special Functions (if any adjustments necessary).

3. In menu operating mode "4.2. Manual", test the switch outputs with the consumers connected and check the sensor values for plausibility. Then set to automatic mode. See "Manual" on page 18



The setup wizard can be accessed in menu 7.2. at any time.



Consider the explanations for the individual parameters on the following pages and check if further settings are necessary for your application.

1. Measurement values

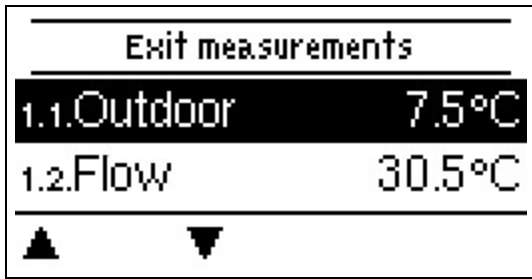

Serve to display the current measured temperatures.



If ,error' appears on the display instead of the measurement value, there may be a defective or incorrect temperature sensor.



If the cables are too long or the sensors are not well-placed, small deviations in the measurement values may occur. In this case, the display values can be compensated by adjustments in the controller. See " Sensor Calibration " on page 23. The selected program, connected sensors and the specific model design determine which measurement values are displayed.

2. Statistics



Serve for function control and long-term monitoring of the system.



For time-dependent functions such as circulation and anti-legionella and the evaluation of system data, it is essential that the time is accurately set on the controller. Please note that the clock continues to run for about 24 hours if the mains voltage is interrupted, and afterward must be reset. Improper operation or an incorrect time may result in data being cleared, recorded incorrectly or overwritten. The manufacturer accepts no liability for the recorded data!

Today

Flow temperature of the last 24 hours

In the graphical overview the characteristics of outdoor and flow temperature for the present day is shown from 0 ... 24 h. The right button changes the unit of time (days) and the two left buttons scroll through the diagram.

28 days

Flow temperature during the last 28 days

In the graphical overview the characteristics of the outdoor and flow temperature during the last 28 days is shown. The right button changes the unit of time (days) and the two left buttons scroll through the diagram.

Operating hours

Here the operating hours of the heating circuit and other switch or signal outputs are displayed. This is the entire time the heating circuit pump and other switch or signal outputs were active. The displayed date in this menu is the date of the last deletion. From this date on the current count is added.

Notifications

Display of the last 20 errors in the system with indication of date and time.

Reset / Clear

Resetting and clearing the selected statistics. Selecting ,all statistics' clears everything except the messages.

3. Periods

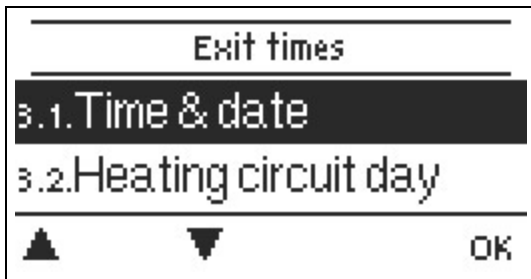

Settings for time, date and operating times for the heating circuit.



The associated temperature reference values are specified in Menu 5, 'Settings'.

Time & Date

Serve to set the current time and date.



For time-dependent functions such as circulation and anti-legionella and the evaluation of system data, it is essential that the time is accurately set on the controller. Please note that the clock continues to run for about 24 hours if the mains voltage is interrupted, and afterward must be reset. Improper operation or an incorrect time may result in data being cleared, recorded incorrectly or overwritten. The manufacturer accepts no liability for the recorded data!

Daylight saving time

If this function is activated, the controller automatically changes to winter time or summer time (DST, Daylight Savings Time).

Heating Circuit (Day)

This menu is used to select the daytime mode times for the heating circuit; three time periods can be specified for each weekday and copied to the following days.



Unspecified times are automatically considered to be night-time mode. The set times are only taken into account in the 'Automatic' heating circuit operating mode.

Heating Circuit Comfort

This menu can be used to select three time ranges for each day of the week in which the heating circuit is supplied with an increased comfort temperature, e.g. for quick heating in the morning.

4. Operating mode

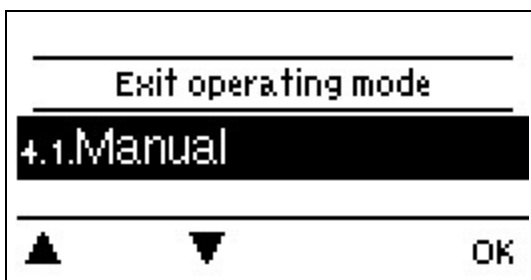

To specify the operating modes for the heating circuit. After an interruption of the mains voltage, the controller automatically returns to the last operating mode selected.



Only in automatic mode does the controller use the set operating times and the correspondingly set target flow temperatures!

Manual

The individual relay outputs, v outputs and the connected consumers can be checked for proper functioning and correct assignment.



The operating mode 'Manual' may only be used by specialists for brief function tests, e.g. during commissioning! Function in manual mode: The relays and thus the connected consumers are switched on and off by pressing a key, with no regard to the current temperatures and set parameters. At the same time, the current measurement values of temperature sensors are also shown in the display for the purposes of function control.

5. Settings

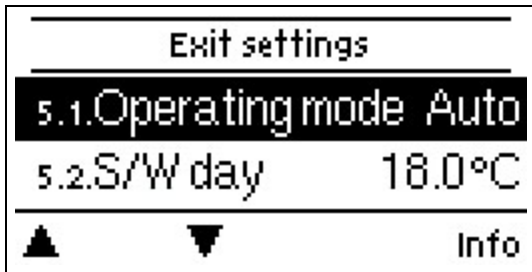

The basic settings for the control function of the heating circuit are applied. Basic settings applied.



By no means does the controller replace the safety appliances on site!

Operating mode

Auto: automatic/normal operation taking into account operating times (day, comfort increase, night reduction).

Reference: fixed flow temperature independent of the outside temperature. The desired flow temperature must be set in Menu 5.8.

Reference program: e.g. for screed heating. For the next 14 days, can be found under Menu 4. different fixed flow temperatures can be entered. After 14 days, the reference temperature of the 14th day is used continuously until the operating mode is changed. Different temperature values can be set in menu 5.4. for every individual day separately.



Set room controllers have no influence on the setpoint program!



If a room controller is set for the respective heating circuit, the set mode or measured room temperature has an influence on the flow temperature of the heating circuit.

S/W Day

Summer / Winter changeover in daytime mode

If this value is exceeded at the outdoor sensor the controller automatically switches the heating circuit off = Summer mode. If the outdoor temperature drops below this value, the heating circuit is switched on again = Winter mode.



In addition to the operating times in normal daytime operation, this setting is also valid for times with activated comfort.

S/W Night

Summer/Winter changeover in night-time mode

If this value is exceeded at outdoor sensor S1 during the nighttime mode times, the controller automatically switches the heating circuit off = Summer mode. If the outdoor temperature drops below this value, the heating circuit is switched on again = Winter mode.

Curve

Type and slope of the heating characteristic curve

The characteristic curve is used to control the heat dissipation of the heating circuit relative to the outdoor temperature. The demand for heat differs due to factors such as the type of building, heating, insulation and outdoor temperature. For this reason, the controller can operate with a normal straight curve (setting ,simple') or split curve (setting ,split').

If ,simple' is selected, the curve is adjusted using the graphic diagram. While setting the slope, the controller also shows the slope value and the calculated target flow temperature at -12 °C as a reference point.

If ,split is selected, the curve is set in the following steps:

1. Outdoor temperature for slope change
2. Slope over outdoor temperature for change
3. Slope below outdoor temperature for change

While setting the slope, the controller also shows the slope value and the calculated target flow temperature at -12 °C as a reference point. In case of repeated adjustment of the split curve, the settings appear in reverse order.

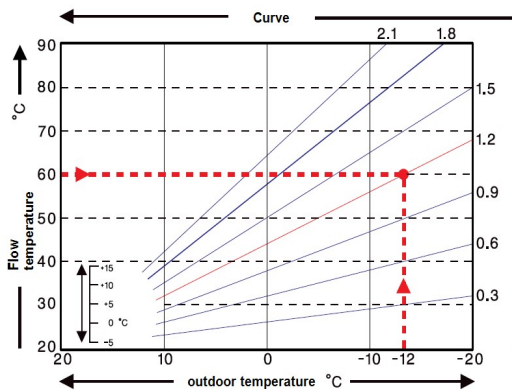

The diagram shows the influence of the selected characteristic curve steepness (standard curve) on the calculated reference flow temperature of the heating unit. The correct characteristic curve is determined by defining the intersection point of the maximal calculated flow temperature (=design temperature) at minimal outdoor temperature.

Example: The design temperature of the heater 60 °C flow at lowest outdoor temperature according to calculation of heat requirement -12 °C. The intersection point renders a slope of 1.2 as the setting.

Day Correction

Parallel characteristic translation

The day correction causes a parallel shift of the heating curve during daytime operating hours, because with certain outdoor temperatures the building might not be optimally heated with the set heating curve. With a non-optimised heating curve, the following situations frequently occur: hot weather = room too cold/cold weather = room too hot. In this case, the slope of the curve should be reduced stepwise by 0.2 points and increases the day correction by 2 ... 4 °C each.

Night Correction

Parallel characteristic translation

The night correction produces a parallel translation of the heating characteristic during the nighttime operating hours. If a negative value is set for the night correction, the reference flow temperature is lowered accordingly during the nighttime operating hours. In this manner, primarily at night, but also during the day when no-one is at home, the room temperature is lowered, thus saving energy. Example: A day correction of +5 °C and a night correction of -2 °C produces a reference flow temperature in nighttime operation that is 7 °C lower.

Comfort Temperature Boost

Parallel characteristic translation

The comfort temperature boost is added to the set day correction. In this manner it is possible to carry out quick heating and/or raise the temperature of living spaces at a certain time each day.

Min. Flow

The minimum flow temperature is the lower limit of the heating curve, and by this, the reference flow temperature of the heating circuit. In addition to that, the minimal flow temperature is the reference flow temperature for the frost protection function.

Max. Flow

This value is the upper limit of the reference flow temperature of the heating circuit. If however, the temperature of the heating circuit exceeds the set value, the heat circuit shuts down until the temperature falls below this value. After 55 seconds, rinse for 5 seconds.



The customer must provide an additional limiting thermostat which is connected to the pumps in series (eg underfloor heating) for safety.

Heating circuit off

If you use a room controller, the heating circuit can also be switched off on the base of the room controller in addition to the switch-off according to outside temperature.

Summer: Heating circuit turns off when the summer/winter time changeover (outside temperature) is exceeded.

Summer + Room: Heating circuit is turned off as soon as the summer/winter time changeover (outside temperature) or the room set-point temperatures are exceeded.

Heat request

The MHCC can request a heat source (burner, heat pump, ...) if the heating circuit does not have enough energy (VL temperature). Therefore either the signal output V1 is used or the request is transferred via the CAN bus to another controller in the CAN network.

Switching: Request is made via signal output V1.

Output signal to V1: "no request" = 0V, "request" = 10V

 If a potential-free contact for the heat source is required, an external switching relay (part no. 77502) must be connected to V1. See "External relay at signal output V(X) (0-10V / PWM)" on page 9.

Modulating: Request is made via signal output V1. The MHCC outputs the requested temperature (calculated target VL) as a voltage via the signal output.

Example: Calculated target VL heating circuit 43 °C, measured VL at sensor S2 40 °C.

If the VL sensor exceeds the setpoint VL by 2K (preference/actual -) for 1 minutes, the MHCC requests a heat source with 4.3V (corresponds to 43 °C setpoint VL).

The requested temperature can be raised with the value "mod. Offset". 0.1 V correspond to 1 °C. If you set an offset of 0.5 V, this results in a requested temperature of 48 °C or 4.8 V (43 °C corresponds to 4.3 V + 0.5 V (offset) = 4.8 V corresponds to 48 °C)

CAN: Request is made via the CAN bus; the heat request must be activated (switching or modulating) on a controller in the network.

This controller receives the request via the CAN bus and passes it to the connected heat source.

Eco mode (during solar charge)

If the MHCC is connected via CAN bus with another controller with activated solar function, the eco mode of the MHCC can be operated in 2 different variants for this function:

Turn off: The function is not started with an active solar charge.

Lowering: The Energy saving mode switches the heating on when T eco is undershot and heats up to T eco + hysteresis when solar charge or solid fuel boiler is active.

Reference/Actual -

Switch on hysteresis for additional heating

This setting determines the allowed undershoot of the heating circuit temperature below the calculated reference flow temperature. If the heating circuit flow temperature and the storage temperature drop below the reference flow temperature by this value, the additional heating will start the additional heat source after a 1 minute delay.

 Heat request is started when the flow temperature is continuously below reference temperature for 1 minute.

Insulation factor

Depending on the selected factor, the outdoor temperature has an influence on the VL temperature calculation after the set delay.

0= Off, 1= 15 minutes, 2= 60 minutes, 3= 120 minutes, 4= 300 minutes

 Better insulated buildings can increase comfort and save energy by increasing the building factor.

Threshold

For Energy saving mode

If eco mode (see "Eco mode") is set to threshold: During a solar charge, this setting value "threshold" is used as the setpoint instead of "TH reference". When the temperature drops below T eco at thermostat sensor 1, the relay is switched on and heats up to Threshold + hysteresis.

Mod. Offset

At modulated heat request the requested temperature can be increased by the value adjusted here.

14-day Reference

If operating mode, 14-day reference value' is selected See " Operating mode " on page 19, the reference flow temperature for each of the 14 days can be set here. Under 4.1.1. the starting time of the program is shown. To restart the program, press ,restart'.

Pressing ,restart' again will reset the 14-day reference program and restart it at Day 1.

6. Protective Functions



The 'Protective functions' can be used by specialists to activate and set various protective functions.



By no means does the controller replace the safety appliances on site!

Seizing Protection

If the anti-seizing protection is activated (daily, weekly, off), the controller switches the heat pump and the mixer on/off at 12:00 noon for 5 seconds to prevent seizing of the pump/valve after long periods of inactivity.

Frost Protection

If the external temperature on sensor S1 goes below 1 °C and the heating circuit is turned off, the heating circuit will automatically be turned on if the frost protection is activated and the reference flow temperature is set at the minimum flow temperature set under See " Min. Flow " on page 22. As soon as the outdoor temperature exceeds 1 °C, the heat circuit is switched off again.



Switching the frost protection function off or setting the minimum flow temperature too low can lead to severe damage to the system.

Min. Flow

The minimum flow temperature is the lower limit of the heating curve, and by this, the reference flow temperature of the heating circuit. In addition to that, the minimal flow temperature is the reference flow temperature for the frost protection function.

Max. Flow

This value is the upper limit of the reference flow temperature of the heating circuit. If however, the temperature of the heating circuit exceeds the set value, the heat circuit shuts down until the temperature falls below this value. After 55 seconds, rinse for 5 seconds.



The customer must provide an additional limiting thermostat which is connected to the pumps in series (eg underfloor heating) for safety.

Discharge Protection

When the buffer discharge protection is activated, the heating circuit pump switches off as soon as the set minimum flow temperature is not reached although the mixer is fully open. Every 5 minutes, the system checks if the flow temperature has been reached.

7. Special Functions



Used to set basic items and expanded functions.



The settings in this menu should only be changed by a specialist.

Sensor Calibration

Deviations in the temperature values displayed, for example, due to cables which are too long or sensors which are not positioned optimally can be compensated for manually here. The settings can be made for each individual sensor in steps of 0.5 °C.

 Settings are only necessary in special cases at the time of initial commissioning by the specialist. Incorrect measurement values can lead to unpredictable errors.

Commissioning

Starting commissioning help guides you in the correct order through the basic settings necessary for commissioning, and provides brief descriptions of each parameter in the display. Pressing the ,esc' key takes you back to the previous value so you can look at the selected setting again or adjust it if desired. Pressing ,esc' more than once takes you back to the selection mode, thus cancelling the commissioning help (See " Commissioning help " on page 16).

 May only be started by a specialist during commissioning! Observe the explanations for the individual parameters in these instructions, and check whether further settings are necessary for your application.

Factory Settings

All settings can be reset, returning the controller to its delivery state.

 All of the controller's parametrization, statistics, etc. will be lost irrevocably. The controller must then be commissioned once again.

Mixer

Here individual parameters for mixer control can be changed.

Turn Time

The mixer is switched on i.e. is opening or closing for the time span set here, then the temperature is measured to control the flow temperature

Pause Factor

The calculated pause time of the mixer is multiplied with the value set here. If the pause factor is ,1', the normal pause time is used, ,0.5' will use half the normal pause time. Setting the pause factor to ,4' would quadruple the pause time.

Increase

If the temperature rises very fast, this value is added to the measured flow temperature so that the mixer's reaction is stronger. If the measured temperature does not rise any more, the measured value is used again. The measurement occurs once every minute.

 Settings are only necessary in special cases at the time of initial commissioning by the specialist. Incorrect measurement values can lead to unpredictable errors.

Room Controller

Room Controller

This value is used to appoint the amount of influence the room temperature has on the reference flow temperature, as a percentage. For each degree deviation between room temperature and set point temperature, the percentage set here is added from the calculated set flow temperature to the set flow temperature or subtracted from it until the min. or max flow values.

Example: Reference room temp.: e.g. 25 °C; room temp.: e.g. 20 °C ±5 °C. Calculated reference temp.: e.g. 40 °C: room controller: 10 % = 4 °C 5 X 4 °C = 20 °C. Accordingly, 20 °C are added to the reference flow temperature, giving 60 °C. If the value is higher than the one set in max. flow temp, the resulting temperature is the one set in max. flow temp.

Room Reference Day

The desired room temperature for day mode.

In combination with the %-value set under "room controller", the difference between reference and actual room temperature influences the reference flow temperature. If the room controller is set to 0 %, this function is deactivated.



For °CALEON room controller without influence.

Room Reference Night

The desired room temperature for night mode.

In combination with the %-value set under "room controller", the difference between reference and actual room temperature influences the reference flow temperature. If the room controller is set to 0 %, this function is deactivated.



For °CALEON room controller without influence.



In the mode Set point program, the room controller has no influence.

Thermostat (X)

The room controller or sensor input is selected here.

When using a °CALEON: select the room set in the °CALEON.

When using an RC21: select RC21-local 1

When using an RC20 or other thermostats and seasonal switches: select the sensor input used here and then select the exact function under "sensor type".

Eco Display Mode

In Eco Display Mode the backlight of the display is switched off if no buttons are pushed for 2 minutes.



If a message exists, the backlight does not switch off until the message has been scanned by the user.

Network

If necessary, the network settings of the connected data logger must be set.

Access Control

This menu lets you give up to 4 users access to the data logger. The users that are registered then have access to the controller or respectively the data logger.

To add a user in the list, select <add user>. Leave the now visible menu open und connect to the address of the connector or respectively the data logger. Your user name is going to appear in this menu and can be selected and confirmed with 'OK'.

Note

You can find the address of the connector or respectively the data logger on the address sticker on the outside of the casing. Pointers and help on how to establish a connection you can find in the enclosed SOREL Connect instructions or the instructions of the data logger.

Select a user with ,OK' to grant access.

To revoke access again, choose one of the users from your list and choose <remove user>.

Ethernet

The data logger's Ethernet connection settings can be set using this menu.

MAC Address

Displays the individual MAC address of the data logger.

Auto-Configuration (DHCP)

If auto-configuration is activated, the data logger requests IP addresses and network parameters from a DHCP server that assigns an IP address, subnet mask, gateway IP and DNS server IP. **If you deactivate the auto configuration (DHCP), you will have to make the required network settings manually!**

IP-Address

Please refer to the router configuration for the IP address to be set.

Subnet Mask

Please refer to the router configuration for the subnetz mask to be set.

Gateway

Please refer to the router configuration for the gateway to be set.

DNS-Server

Please refer to the router configuration for the DNS server to be set.

CAN bus ID

Here you can see the ID of the controller on the CAN bus.

Sensor send interval

The send interval determines how often the sensor and output values of the controller may be send via CAN. If a value changes, it is sent and starts the interval. The next values are not sent until the interval has expired. If no value changes, nothing is sent.

 If there are several controllers in the CAN network, a too short send interval can lead to an overload of the CAN network.

8. Menu Lock

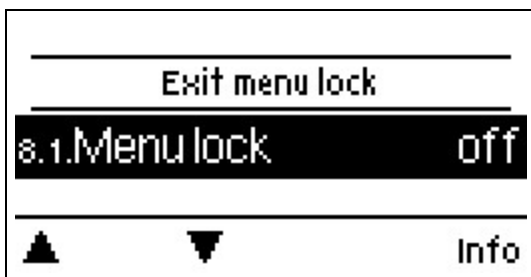

Secure the controller against unintentional changing and compromise of basic functions.

Menu lock active = "On"

Menu lock off = "Off"

In addition, the "Simple" menu view can be used to hide menu items that are not necessary for the daily use of the controller after commissioning. The menu item "Menu lock on/off" is also hidden when the "Simple" menu view is selected!

The menus listed below remain completely accessible despite the menu lock being activated, and can be used to make adjustments if necessary:

1. Measurement values
2. Statistics
4. Settings
6. Special Functions
7. Menu lock
9. Language

9. Service Values

9.1.	MHCC
9.2.	15248
9.3. Room controller	5
▲ ▼	

Serve for remote diagnosis by a specialist or the manufacturer in the event of errors, etc.



Enter the values into the table when an error occurs.

10. Language

10.1. Deutsch
10.2. English
10.3. Nederlands
▲ ▼ OK

To select the menu language. During initial commissioning and longer power interruptions, the query is made automatically. The choice of languages may differ depending on the model. Language selection is not available for every model.

Malfunctions/Maintenance

Replacing the Fuse



Repairs and maintenance may only be performed by a specialist. Before working on the unit, switch off the power supply and secure it against being switched on again! Check that there is no power flowing!



Only use the included safeguard or a similar safeguard with the following specifications: T2A / 250 V.

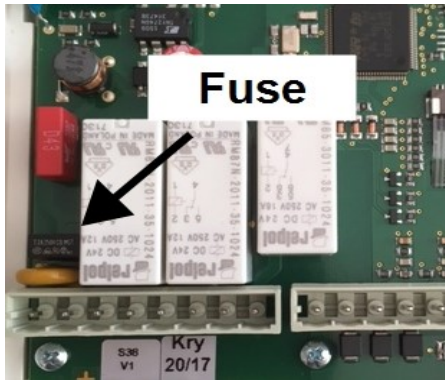

If the mains voltage is switched on and the controller still does not function or display anything, then the internal device fuse may be defective. First find the external fault source (e.g. pump), replace it and then check the device fuse.

To replace the device fuse, open the device as described under "See " Wall Installation " on page 7", remove the old fuse, check it and replace if necessary.

Then first recommission the controller and check the function of the switch outputs in manual mode as described in Section 4.2. .

Possible error messages

Possible error messages

Notes for the specialist

Sensor x defective	Means that either the sensor, sensor entrance on the controller or the connecting wire was defective (See " Temperature Resistance Table for Pt1000 Sensors " on page 10).
Restart	Means that the controller was restarted, for example, due to a power outage. Check date & time!
Time & Date	This display appears automatically after a longer network disruption, because the time & date must be examined and, if applicable, adjusted.

Maintenance

 In the course of the general annual maintenance of your heating system, the functions of the controller should also be checked by a specialist and the settings should be optimized if necessary.

Performing maintenance:

- Check the date and time See " Time & Date " on page 18
- Assess/check plausibility of statistics See " Statistics " on page 17
- Check the error memory See " Notifications " on page 17
- Verify/check plausibility of the current measurement values See " Measurement values " on page 17
- Check the switch outputs/consumers in manual mode See " Manual " on page 18
- Possible optimization of the parameters setting (**only on customers request**)

Tips

 The service values include not only current measurement values and operating states, but also all of the settings for the controller. Write the service values down just once after commissioning has been successfully completed.

 In the event of uncertainty as to the control response or malfunctions the service values are a proven and successful method for remote diagnosis. Write the service values down at the time that the suspected malfunction occurs. Send the service value table by fax or e-mail with a brief description of the error to the specialist or manufacturer.

 To protect against loss of data, record any statistics and data of particular importance at regular intervals.

Support Guideline

If there are errors with your device, please proceed as follows:

1. Read user manual
2. Check FAQ
3. Watch help-video on YouTube
4. Talk to an installation technician/tradesman
5. Contact SOREL Support - provide the following information:

What is the Problem?	<ul style="list-style-type: none">• Installation problem• New problem• Change request
Controller Type/Controller Name (9.1.)	
Software Version (9.2.)	
Program (7.1.)	
Additional function (7.7. - 7.12.)	
Accessories (e.g. room thermostats + Software Version)	
Sensor values of the sensors (1.1. - 1.10.)	
Error messages/frequency of error/error description	
Further Information	

Final Declaration

Although these instructions have been created with the greatest possible care, the possibility of incorrect or incomplete information cannot be excluded. Subject as a basic principle to errors and technical changes.

Date and time of installation:

Name of installation company:

Space for notes:

Your specialist dealer:

Manufacturer:

SOREL GmbH Mikroelektronik
Reme-Str. 12
D - 58300 Wetter (Ruhr)

+49 (0)2335 682 77 0
+49 (0)2335 682 77 10

info@sorel.de
www.sorel.de

Version: 11.10.2021